

LINHA **PESADA**

auto
PARTS
molas&estamparia
AUTOMOTIVA

www.autopartsmolas.com.br



EDIÇÃO
2024



ÍNDICE

■ LINHA PESADA

CARRETA	PÁG 01
CHEVROLET	PÁG 03
FORD	PÁG 03
IVECO	PÁG 04
MERCEDES BENZ	PÁG 05
SCANIA	PÁG 10
VOLARE	PÁG 11
VOLKSWAGEN	PÁG 12
VOLVO	PÁG 14
ÔNIBUS	PÁG 15
CUÍCA DE FREIO	PÁG 15
TRAVA DA CARROCERIA	PÁG 16
TRAVA	PÁG 17

CARRETA
mola

interno 210mm



aço 4,00mm

5MB-404

Carreta Randon (211.3010)
mola do patim fixa simples macia

* 000.993.2623 ** 5301

interno 190mm



aço 4,00mm

5MB-404/C

Carreta Randon (211.3010)
mola do patim fixa simples macia

* Lançamento

interno 205mm



aço 4,00mm

5MB-408

Carreta
mola do patim dupla móvel sistema Bendix

* 000.993.0023 ** 5305

interno 205mm



aço 5,00mm

5MB-408R

Carreta
mola do patim dupla móvel sistema Bendix

* Lançamento

* 000.993.0023 ** 5305

interno 135mm



aço 3,00mm

5MB-410

Carreta (225.8200)
mola do patim gancho móvel menor

* 000.993.0025 * 225H1230

interno 130mm



aço 3,00mm

5MB-410A

Carreta
mola do patim gancho móvel

* 000.993.1113

interno 115mm



aço 3,00mm

5MB-410B

Carreta
mola do patim gancho móvel

* 000.993.1115

interno 132mm



aço 3,00mm

5MB-410C

Carreta
mola do patim gancho móvel

* 000.993.0025 ** 5311

interno 140mm



aço 3,00mm

5MB-410M

Carreta (2258-H-1230)
mola do patim gancho móvel maior

* 000.993.1125

interno 190mm



aço 4,00mm

5MB-448

Carreta
mola do patim dupla móvel sistema Bendix

* 000.993.1923 ** 5302

interno 190mm



aço 5,00mm

5MB-448R

Carreta
mola do patim dupla móvel sistema Bendix

* Lançamento

* 000.993.1923 ** 5302

interno 220mm



aço 4,00mm

5MB-449

Carreta (225.8196)
mola do patim dupla móvel freio Master - com rabicho

* 000.993.2223 ** 5310

interno 220mm



aço 5,00mm

5MB-449R

Carreta (225.8196)
mola do patim dupla móvel freio Master - com rabicho

* Lançamento

* 000.993.2223 ** 5310

interno 220mm



aço 4,00mm

5MB-450

Carreta (2113.124)
mola do patim dupla móvel freio Master - sistema Bendix

* 000.993.2423 ** 5309

interno 195mm



aço 3,00mm

5MB-451

Carreta Randon (211.300010)
mola da sapata de freio antiga

* 000.993.2523 ** 5313

interno 213mm



aço 4,00mm

5MB-457

Carreta Guerra 10/
mola do patim do freio fixa

Carreta (2113.126)
trava do rolete do patim freio Master



aço 1,60mm

5MB-459

* 381.421.8290 ** 5319

interno 223mm



aço 4,00mm

5MB-482

Carreta Guerra 06/10
mola do patim de freio dupla fixa

* 000.993.4223 ** 5314

interno 235mm



aço 4,00mm

5MB-504

Carreta Guerra 10/
mola do patim de freio fixa dupla fixa

* 000.993.4223 ** 5314

interno 235mm



aço 5,00mm

5MB-504/R

Carreta Guerra 10/
mola do patim de freio fixa dupla fixa

* 000.993.4223 ** 5314

interno 208mm



aço 5,00mm

5MB-505

Carreta (freio a disco)
mola do patim dupla móvel

* 000.993.2323

interno 210mm



aço 5,00mm

5MB-505R

Carreta (freio a disco)
mola do patim dupla móvel com rabicho

* 000.993.2324 ** 5317

externo 88mm



aço 6,00mm

5MB-506

pino de retenção da mola sistema Bendix

* 226.0421

interno 200mm



aço 4,50mm

5MB-507

Carreta
mola do patim dupla móvel com rabicho

* 000.993.2023

interno 210mm



aço 5,00mm

5MB-508

Carreta Q Plus 04/
mola do patim dupla móvel freio Master

* 000.993.0123 ** 5316

interno 210mm



aço 5,00mm

5MB-508EX

Carreta Randon
mola do patim dupla móvel freio Master - gomo 31mm

* 000.993.5223

interno 600mm



aço 3,00mm

5MB-510

mola do paracheque

* 000.993.0903 ** 5326

interno 300mm



aço 3,00mm

5MB-510C

mola do parachoque

interno 940mm



aço 3,00mm

5MB-510M

mola do parachoque

* 000.993.0803 ** 5327

Ø 16mm



aço 3,00mm

5MB-512

Carreta
trava tipo alfinete
bica da Randon

* 389.320.7031 ** 5318

Ø 19mm



aço 3,00mm

5MB-512M

Carreta
trava tipo alfinete
bica da Randon

*

interno 315mm



aço 9,00mm

5MB-513

Facchini
mola do cambão da julieta
linha canaveira

* 2113.114

interno 315mm



aço 11,00mm

5MB-513M

Facchini
mola do cambão da julieta
linha canaveira (reforçada)

* 2113.114

interno 370mm



aço 9,00mm

5MB-514

Facchini
mola do cambão da julieta
linha canaveira

interno 90mm



aço 3,40mm

5MB-517M

Jost Brasil
mola da sapata móvel
pé mecânico B200S

* AD000511J00

interno 145mm



aço 3,00mm

5MB-540

Carreta Guerra moderna
mola do patim de freio
auxiliar

* 000.993.1425 ** 225H1250

externo 370mm



aço 11,00mm

5MB-541

FNV
mola do cambão sem parafuso
linha canaveira

** 5343

externo 370mm



aço 11,00mm

5MB-542

FNV
mola do cambão com parafuso
linha canaveira

** 5344

interno 360mm



aço 9,00mm

5MB-543

linha canaveira
mola do cambão da julieta
com gancho

interno 360mm



aço 8,00mm

5MB-544

linha canaveira
mola do cambão da julieta
com gancho longo

* 211.300.114 ** 5341

interno 360mm



aço 11,00mm

5MB-544R

linha canaveira
mola do cambão da julieta
com gancho longo

* 211.300.114 ** 5342

interno 200mm



aço 4,00mm

5MB-568

Carreta
mola dupla do patim do freio

* 2258Q433

interno 200mm



aço 4,50mm

5MB-568EX

Carreta
mola dupla do patim do freio

* 2258Q433

** Lançamento*

interno 200mm



aço 4,00mm

5MB-569

Carreta
mola dupla do patim do freio
com rabicho

** 5304

interno 205mm



aço 4,00mm

5MB-570

Carreta
mola dupla do patim do freio
com rabicho

** 5306

interno 210mm



aço 4,00mm

5MB-571

Carreta
mola dupla do patim do freio

** 5307

interno 210mm



aço 4,00mm

5MB-572

Carreta
mola dupla do patim do freio
com rabicho

** 5308

Ø 26mm



aço 3,00mm

5MB-573

mola tipo alfinete cupilha

externo 320mm



aço 3,00mm

5MB-574

mola do parachoque
2 argolas centradas nas pontas

** 5321

externo 380mm



aço 3,00mm

5MB-575

mola do parachoque
2 argolas centradas nas pontas

** 5322

externo 350mm



aço 3,00mm

5MB-576

mola do parachoque
2 argolas centradas nas pontas

** 5323

externo 500mm



aço 3,00mm

5MB-577

mola do parachoque
2 argolas centradas nas pontas

** 5324

externo 550mm



aço 3,00mm

5MB-578

mola do parachoque
2 argolas centradas nas pontas

** 5325

interno 86mm



aço 2,00mm

5MB-580

Carreta
mola gavião quinta roda
Maxion 2"

* 2400110657 ** 5337

interno 77mm

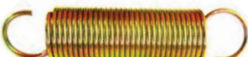

aço 1,60mm

5MB-581

Carreta
mola do fecho Jost gavião 2"

* 2400110633 ** 5339

interno 130mm



aço 4,00mm

5MB-582

Carreta
mola dupla de retenção retorno
manipulo Jost eixos e comp.

* 2400110645 ** 5338

interno 170mm



mola interna - aço 2,00mm
mola externa - aço 2,50mm

5MB-583

Carreta
mola dupla gavião Maxion

* 2400110669 ** 5336



Ø 60mm

aço 3,00mm

5MB-584

Carreta
anel trava do cubo

* 0009045.050001

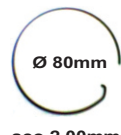

Ø 80mm

aço 2,00mm

5MB-585

Carreta
trava rolamento do pinhão
maior (HD4-HL4)

* 385.994.0037



aço 2,50mm

5MB-598

CH16252, 16281
mola do acelerador retrocesso

* 382.993.7210

interno 145 mm



aço 2,50mm
aço 3,40mm

5MB-600

mola dupla do manipulo
JOST 2 POLEGADAS

* 260000062



5MB-4005 * Lançamento

mola de torção JOST
quinta roda 3 1/2 «

AD01097JOO

AUTOPARTS
molares automotivas

CARRETA
diverso



9MB-547

Carreta
trava do rolete do patim
chapa

* 381.421.8890 ** 5320



9MB-579

Carreta
conjunto trava do rolete do patim
pingo d'água - 901.699

* 381.421.8090 ** 5345

AUTOPARTS
molares automotivas

CHEVROLET
reparo da sapata
de freio



2MG-031

C, D60 71/79
1 roda - dianteira
sistema Bendix

* BE1T2K296B *3GM48 *2005 **104

AUTOPARTS
molares automotivas

CHEVROLET
reparo da sapata
de freio completo

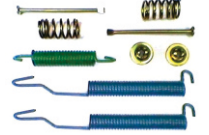

4MG-031

C, D60 71/79
1 roda - dianteira
pino 70mm - sistema Bendix

* 223 ** 243

AUTOPARTS
molares automotivas

CHEVROLET
mola

interno 150mm



aço 1,60mm

5MG-043

D60, D70, D80
mola de retrocesso do pedal
da embreagem

* 3.365.114 ** 332

interno 190mm



aço 2,00mm

5MG-065

D70
mola de retrocesso do pedal
da embreagem

* 3.749.26 ** 337

AUTOPARTS
molares automotivas

FORD
reparo da sapata
de freio



2MD-141

F600, F7000, F11000
1 roda - dianteiro
sistema Bendix

* BE1T2K296B * 3FO47 * 3009 **126



2MD-189

F7000
1 roda - traseiro

* 225.0189

AUTOPARTS
molas automotivas

FORD

reparo da sapata
completo



4MFOR-849C

CARGO 4T 94/, 816
1 roda - dianteira / traseira

* 2RG.607.041 ** BG1T2W14WHAA

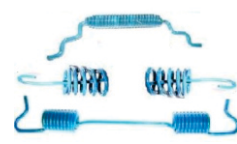

4MFOR-850C

CARGO 14.18, 16.18, F11000, 816
1 roda - dianteira / traseira

* BF5X2W146AA

AUTOPARTS
molas automotivas

FORD

mola

interno 305mm



aço 1,80mm

5MD-140

F600
mola do pedal da embreagem

* BE1C7523A

interno 150mm



aço 1,60mm

5MD-152

F7000
mola do pedal da embreagem

* BD2T752A ** 370

interno 85mm



aço 1,80mm

5MD-157

F600, F750, F7000
mola do pedal da embreagem

* TUCG7523A ** 365

interno 370mm



aço 1,80mm

5MD-172

F600, F11000, F12000, F22000
mola do retorno da embreagem

* BD2T523B ** 375

interno 255mm



aço 4,00mm

5MFOR-803

F4000
mola de retorno do patim de
freio a disco

* 2260285

interno 150mm



aço 4,00mm

5MFOR-807

CAMINHÃO 91/97
mola do patim dianteiro
bicônica

* 85HU2W146A ** 6802

interno 240mm



aço 4,00mm

5MFOR-808

CARGO
mola do patim do freio
dianteiro

* 85NV2296A ** 6803

interno 200mm



aço 4,00mm

5MFOR-809

mola do patim do freio
dianteiro

* 85HV2296B ** 6804

interno 220mm



aço 4,00mm

5MFOR-810

mola do patim do freio
dianteiro

** 6805

interno 220mm



aço 4,00mm

5MFOR-1871

F350, F8000, F8500
mola do patim do freio
traseiro

* B42T2036 / A225.0655 ** 6808

interno 130mm



aço 1,00mm

5MFOR-1889

mola do acelerador

* XC459834BB ** 6810

interno 100mm



aço 1,00mm

5MFOR-1890

CARGO
mola do retorno do acelerador

* 1C459834AA ** 6811

externo 60mm



aço 3,40mm

5MFOR-1891

CARGO
mola do retorno do pedal da
embreagem

* TNA721363 ** 6812

externo 60mm



aço 3,40mm

5MFOR-1892

CARGO
mola do retorno do pedal da
freio

* TJG721363 ** 6813

interno 155mm



aço 4,5mm

5MFOR-1893

CARGO C-1119
mola do patim do freio

* MO 216

interno 70mm



5MFOR-1894

CARGO 712 A 5031
mola eixo pedal do acelerador

*TJG721619

35,0mm



aço 1,40mm

5MFOR-1895

CARGO 712 A 1415
mola torção / haste liberação
da cabine

* 81DB-5B122-BB

* Lait-cimento

AUTOPARTS
molas automotivas

IVECO

reparo da sapata
de freio



4IVC-8903

VERTIS 90V16, 90V18
1 roda - dianteira

* 500053217

IVECO

freio a disco

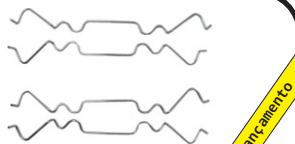

11VC-2089

Nova Daily 3.0 16V, 70C16 08/
2 rodas - dianteira

* 93161976C

70mm



51VC-2050

mola anti-ruído pastilha de freio
dianteira

IVECO

mola



aço 13,00mm

51VC-5013

TECTOR / CURSOR
mola fixação suspensão cabine

* 58002233204

interno 216mm



aço 5,00mm

51VC-5014

EUROCARGO 6x2
mola do patim de freio

* 503355153 * 2258M1287

interno 205mm



aço 5,00mm

51VC-5016

**EUROCARGO, STRALIS,
TECTOR, VERTIS**
mola do patim 3° eixo

* 500052926 * 2258Z416

interno 135mm



aço 3,00mm

51VC-5017

**EUROCARGO, STRALIS,
TECTOR, VERTIS**
mola do patim gancho móvel

* 2258H1230

interno 160mm



aço 4,00mm

51VC-5018

VERTIS 90V16
mola patim de freio

* 500053790 * 500053217 * 225FM03

interno 132mm



aço 3,00mm

51VC-5019

**EUROCARGO, STRALIS,
TECTOR, VERTIS**
mola do patim gancho móvel

* 500053214 * 500053780 * 2258Z1378

interno 220mm



aço 4,50mm

51VC-5020

**EUROCARGO, STRALIS,
TECTOR, VERTIS**
mola do retorno patim de freio

* 503356052 * 2258U619

interno 120mm



aço 3,00mm

51VC-5021

**NOVA DAILY 3.0 16V
70C16/70C17 .../19 - 70-170**
mola patim de freio

* 50006868

interno 227mm



aço 5,50mm

51VC-5022

IVECO BUS 170s28
mola do retorno patim preta

* 500057411 * MO 223

MERCEDES-BENZ

**reparo da sapata
de freio**



2MB-414

608D, 708E
1 roda - dianteira / traseira

* 3MB31 ** 5102



2MB-424

709, 814, 912
dianteira / traseira
parcial - 5 molas

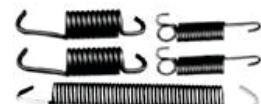

2MB-446

709, 814, 912
1 roda - dianteira / traseira
parcial

MERCEDES-BENZ

**reparo centralizador
de freio**



3MB-430

709, 814, 912
1 roda - dianteira / traseira
pino 75mm

* 688.586.0442 ** 5109



3MB-498

Sprinter
1 roda - dianteira / traseira
pino 52mm



3MB-500

608D, 708E
1 roda - dianteira / traseira
pino 74mm

* 309.586.0442 * 2MB21 ** 5112

MERCEDES-BENZ

**reparo da sapata
de freio completo**

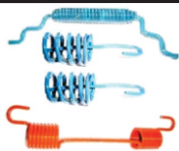

4MB-400

710 PLUS
reparo da sapata de freio
1 roda - dianteira

* 000.423.2392

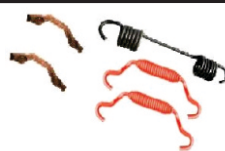

4MB-401

ACIELO 815
reparo da sapata de freio
1 roda - dianteira

* 2258FM03



4MB-414

608D, 708E
1 roda - dianteira / traseira
pino 75mm

* 308.586.9042 * 7MB71 ** 5116

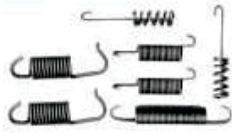

4MB-433

912
reparo da sapata de freio
1 roda - dianteira / traseira
* 688.421.0092

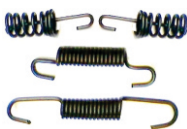

4MB-516

Sprinter
reparo da sapata de freio
1 roda - traseira
*126.420.0038



4MB-527

Sprinter
1 roda - traseira
pino 52mm - sistema Bendix
*000.421.3590



4MB-539

709, 912
1 roda - dianteira / traseira
pino 75mm
* 688.421.0192 ** 5115



4MB-4006

* Laitamento

SPRINTER 311 313 415 515
2012 / 2015
reparo da sapata de freio
* 000.993.5307



MERCEDES-BENZ

mola

externo 250mm



aço 5,00mm

5MB-401

1313, 2213
mola do patim de freio
dianteiro
* 341.421.0092 ** 5001

externo 240mm



aço 4,00mm

5MB-402

1111, 1113
mola do patim de freio
dianteiro - reforçada
* 322.421.0392 ** 5002

externo 245mm



aço 4,00mm

5MB-403

1113, 1313, 1513, 1933
mola do patim de freio a ar
dianteiro / traseiro
* 617.993.0610 ** 5003

interno 193mm



aço 5,00mm

5MB-405

1113, 1313, 1513, 2013, 2213
mola do pedal da embreagem
mecânica
* 352.993.1310 ** 5004

interno 250mm



aço 5,00mm

5MB-406

1313, 1513, 2013, O355, O362
mola do patim de freio
traseiro
* 302.993.0610 ** 5005

interno 200mm



aço 3,40mm

5MB-407

1113
mola do patim de freio
traseiro - reforçada
* 312.423.2192 ** 5006

interno 135mm



aço 3,40mm

5MB-409

1113, 1116, LP, LPO, OH1419
mola do garfo da embreagem
gancho fixo
* 312.993.2510 ** 5007

interno 80mm



aço 2,00mm

5MB-411

608D, 708E
mola do pedal da embreagem
hidráulica
* 309.993.1110 ** 5008

interno 120mm



aço 1,30mm

5MB-412

608D, 708E, 709, OM366
mola do acelerador
* 319.993.0510 ** 5009

interno 230mm



aço 1,40mm

5MB-413

1313, 1316, 1513, 1516, 1519
mola do acelerador
média turbo
* 303.993.0610 ** 5010

interno 208mm



aço 1,40mm

5MB-415

1111
mola do acelerador
universal
* 322.993.0310 ** 5011

interno 135mm



aço 1,80mm

5MB-416

1313
mola de freio motor
* 352.993.0710 ** 5012

interno 30mm



aço 1,00mm

5MB-417

1113, 1116, 1313, 1316, 1513
mola da fechadura da porta
* 331.727.7041 ** 5013

externo 31mm



aço 2,00mm

5MB-418

608D, 708, L1113 ao O362
trava do cubo do rolamento
da embreagem
* 340.254.0013 ** 5085

interno 180mm



aço 1,00mm

5MB-419

1113, 1313
mola do acelerador
macia
* 066.993.0210 ** 5014

interno 180mm



aço 1,30mm

5MB-419A

1113, 1313
mola do acelerador
média
* 303.993.0610 ** 5015

interno 230mm



aço 1,80mm

5MB-420

O355, O364, O370
mola do acelerador
motor traseiro reforçada
* 315.993.0210 ** 5016

interno 160mm



aço 2,50mm

5MB-421

1113
mola do freio motor
* 321.993.0610 ** 5017

















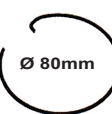







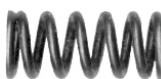

externo 66mm



aço 2,00mm

5MB-422

1113
mola auxiliar do patim de freio
dianteira / traseira
* 302.993.0310 ** 5018

<p>interno 50mm</p>  <p> aço 2,00mm</p> <p>5MB-425</p> <p>LS 1630, 32, 1929, 35, 41, 45 mola do retorno do pedal da embreagem</p> <p>* 388.993.7010 ** 5020</p>	<p>externo 19mm</p>  <p> aço 1,30mm</p> <p>5MB-426</p> <p>mola do filtro copinho da bomba manual</p> <p>* 000.993.0005 ** 5021</p>	<p>interno 140mm</p>  <p> aço 4,00mm</p> <p>5MB-427</p> <p>1113, 2013 mola do pedal do freio óleo e embreagem hidráulica</p> <p>* 312.993.1510 ** 5022</p>	<p>interno 230mm</p>  <p> aço 3,40mm</p> <p>5MB-428</p> <p>1113 mola do patim do freio dianteiro - simples</p> <p>* 322.421.0392 ** 5023</p>
<p>interno 230mm</p>  <p> aço 4,00mm</p> <p>5MB-429</p> <p>1113 mola do patim do freio dianteira - reforçada</p> <p>* 322.421.0392 ** 5024</p>	<p>Ø 80mm</p>  <p> aço 2,00mm</p> <p>5MB-431</p> <p>1113, O362 trava do rolamento do pinhão</p> <p>* 322.994.0137 ** 5086</p>	<p>Ø 80mm</p>  <p> aço 2,00mm</p> <p>5MB-431A</p> <p>L1519 trava do rolamento do pinhão - maior</p> <p>* 302.994.0037 ** 5087</p>	<p>Ø 45mm</p>  <p> aço 2,00mm</p> <p>5MB-431B</p> <p>L1519 trava da ponta do pinhão menor</p> <p>* 317.994.0037</p>
<p>interno 136mm</p>  <p> aço 3,00mm</p> <p>5MB-435</p> <p>1113, 1513 mola do garfo da embreagem gancho giratório</p> <p>* 312.993.2510 ** 5026</p>	<p>interno 100mm</p>  <p> aço 3,00mm</p> <p>5MB-436</p> <p>608D, 709E mola do patim de freio dianteira / traseira - pequena</p> <p>* 309.421.0592 ** 5027</p>	<p>interno 125mm</p>  <p> aço 3,00mm</p> <p>5MB-437</p> <p>608D, 709E mola do patim de freio dianteira / traseira - grande</p> <p>* 309.993.0910 ** 5028</p>	<p>interno 190mm</p>  <p> aço 3,00mm</p> <p>5MB-438</p> <p>608D, 708E mola da sapata do freio traseira (freio de mão)</p> <p>* 309.421.0792 ** 5029</p>
<p>interno 135mm</p>  <p> aço 2,50mm</p> <p>5MB-439</p> <p>321 mola do afogador</p> <p>** 5030</p>	<p>externo 35mm</p>  <p> aço 1,80mm</p> <p>5MB-441</p> <p>312, 321 mola do rolamento desengate da embreagem</p> <p>* 312.254.1013 ** 5088</p>	<p>externo 17mm</p>  <p> aço 1,20mm</p> <p>5MB-442</p> <p>mola trava do eixo piloto 17mm</p> <p>* 321.993.1201 ** 5032</p>	<p>externo 22mm</p>  <p> aço 1,20mm</p> <p>5MB-444</p> <p>1113 ao O362 mola do garfo de câmbio 22mm</p> <p>* 312.993.1001 ** 5033</p>
<p>externo 100mm</p>  <p> aço 5,00mm</p> <p>5MB-445</p> <p>L1212, 1414, 1618 mola reparo da embreagem hidráulica - menor grossa</p> <p>* 386.993.7001 ** 5034</p>	<p>externo 30mm</p>  <p> aço 3,00mm</p> <p>5MB-452</p> <p>1113, 2213, 1418, 1618, L1218 mola da alavanca do câmbio</p> <p>* 317.993.0501 ** 5036</p>	<p>interno 115mm</p>  <p> aço 3,00mm</p> <p>5MB-453</p> <p>1113 ao 2213 mola do garfo da embreagem fixa</p> <p>* 044.993.0210 ** 5037</p>	<p>interno 250mm</p>  <p> aço 5,00mm</p> <p>5MB-454</p> <p>O355, O362, O364, OF1313 mola do patim do freio dianteiro</p> <p>* 344.421.7092 ** 5038</p>
<p>externo 105mm</p>  <p> aço 3,00mm</p> <p>5MB-456</p> <p>709, 912, 1214, 1418 mola do pedal do freio</p> <p>* 384.993.7020 ** 5040</p>	<p>externo 70mm</p>  <p> aço 4,50mm</p> <p>5MB-461</p> <p>LO 914, LK 1721, L 2318 mola da alavanca do câmbio</p> <p>* 000.267.0093</p>	<p>externo 33mm</p>  <p> aço 3,00mm</p> <p>5MB-462</p> <p>321, 1111, 1113 mola de pressão da alavanca de câmbio</p> <p>* 317.993.0501</p>	<p>interno 90mm</p>  <p> aço 3,00mm</p> <p>5MB-465</p> <p>608D mola do garfo da embreagem</p> <p>* 309.993.0010 ** 5045</p>
<p>externo 30mm</p>  <p> aço 1,00mm</p> <p>5MB-466</p> <p>321 mola do trambulador</p> <p>* 312.993.1701 ** 5046</p>	<p>externo 19mm</p>  <p> aço 1,60mm</p> <p>5MB-468</p> <p>OM314, OM352, OM364 mola do eixo do balancim cônica</p> <p>* 312.993.0005 ** 5048</p>	<p>externo 60mm</p>  <p> aço 2,00mm</p> <p>5MB-471</p> <p>OM352 mola trava do eixo balacim</p> <p>* 312.993.0025</p>	<p>externo 40mm</p>  <p> aço 1,60mm</p> <p>5MB-476</p> <p>OM314, 352, 364, 366 mola do eixo do balancim grande</p> <p>* 312.993.0701 ** 5054</p>



externo 59mm



aço 1,20mm

5MB-478

1929, 1932, 2314, 2318, 2325
trava do cubo do rolamento da embreagem

* 317.993.0225 ** 5090

aço 1,80mm

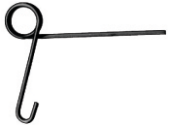

5MB-479

mola trinco do capô

** 5056

interno 260mm



aço 5,00mm

5MB-480

O355, O362, O364, OF1313
mola do patim de freio dianteiro

* 344.421.7092 ** 5057

externo 115mm



aço 5,00mm

5MB-481

608D, 708E, OF1318, OH1318
mola reparo da embreagem hidráulica (maior)

* 110.993.0501 ** 5058

interno 180mm



aço 3,40mm

5MB-483

O370, O371
mola do esticador da correia ventilador

* 364.993.7510 ** 5059

externo 22mm



aço 0,80mm

5MB-487

608
mola do entalhado do câmbio

* 324.993.0301 ** 5062

interno 235mm



aço 5,50mm

5MB-489

L1214, 1414, 1614, 1618
mola do capô bicudinho HPN

* 384.887.7179 ** 5064

interno 115mm



aço 2,00mm

5MB-492

708, 709, 912
mola do patim traseira

** 5067

interno 85mm



aço 2,00mm

5MB-493

708, 709, 912
mola do patim traseira

** 5068

interno 190mm



aço 3,00mm

5MB-494

312, 321
mola do patim de freio traseiro

* 312.423.2092 ** 5069

externo 95mm



aço 5,00mm

5MB-495

608D, 708E, OF1318
mola auxiliar do pedal da embreagem hidráulica

* 110.993.0501 ** 5070

interno 142mm



aço 3,00mm

5MB-496

504718, 22. 2533
mola da engrenagem

* 387.262.1093

externo 52mm



aço 5,00mm

5MB-497

Fp1653, OH16281
mola pressão da embreagem

* 382.993.7001

aço 4,00mm



5MB-501

Atego
anel trava de segurança embreagem

externo 320mm



aço 4,00mm

5MB-509D

709, 712, L1218, 1418, 1618
tirante da fechadura da porta lado direito

* 673.723.0169

externo 320mm



aço 4,00mm

5MB-509E

709, 712, L1218, 1418, 1618
tirante da fechadura da porta lado esquerdo

* 673.723.0069

interno 245mm



aço 4,00mm

5MB-518

O371, OF1313, L1218
mola do patim de freio a ar dianteiro / traseiro - moderna

* 388.993.7110

interno 255mm



aço 5,00mm

5MB-520

1313, 1517, OH 1419, 1420
mola do patim traseiro

* 360.993.0110

externo 40mm



aço 2,00mm

5MB-521

OM352, 366
mola niple ligação balancim

* 312.993.4701 ** 5071

interno 180mm



aço 4,00mm

5MB-523

912
mola do freio a ar

externo 46mm



aço 3,00mm

5MB-524

OM447, 449, LS1935, 38, 41
mola da alavanca da regulagem do acelerador

* 403.993.1110 ** 5072

externo 27mm



aço 1,20mm

5MB-525

OM314, 352, 364, 366
mola válvula do radiador óleo

* 312.993.2601 ** 5073

aço 3,10mm



5MB-526

709, 912
trava do rolamento da embreagem - cabeça de gato

* 000.252.1573 ** 5101

interno 174mm



aço 3,40mm

5MB-529

1113, 2013
mola do pedal de freio a ar

* 352.993.1010 ** 5074

interno 235mm



aço 3,40mm

5MB-530

1113, 2013
mola da alavanca dupla pedal freio

* 345.993.7010 ** 5075

interno 105mm



aço 1,60mm

5MB-533

OF1721
mola do acelerador zincada

* 376.993.7010 ** 5076

externo 13mm



aço 1,00mm

5MB-534

709, 912, L1218, 1620
mola da maçaneta interna da porta

* 673.993.0020 ** 5077

externo 18mm



aço 0,50mm

5MB-537

mola válvula da bomba alimentadora - 18mm

* 000.091.0319 ** 5078

Ø 63mm
aço 3,00mm

5MB-538

OM366
anel trava peneira bomba óleo do motor

* 007993.070100 ** 5096

externo 134mm



aço 3,40mm

5MB-548

Carreta e Truck
mola da câmara do spring brake

interno 135mm



aço 3,40mm

5MB-549

608, 710, 912, 914
mola do patim de freio

externo 100mm



aço 1,60mm

5MB-550

mola do Rodoar

* 369.401.1013 ** 5328

externo 268mm

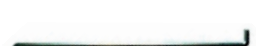

aço 4,00mm

5MB-551

1113 ao 2213
tirante da fechadura da porta

* 344.723.0069

externo 268mm



aço 4,00mm

5MB-552

1113, 1313, 1513, 2013 83/
tirante da fechadura da porta (cara preta)

* 331.723.0069

externo 162mm



aço 6,00mm

5MB-553

712C, 914C, LO914
grampo trava da pastilha de freio

* 000.421.0469 ** 5126

externo 95mm



aço 4,00mm

5MB-555

1113 ao 2213
tirante do botão trava da porta

* 344.723.0169

externo 150mm



aço 3,00mm

5MB-556

L1622, 1624, LS1634
tirante da fechadura da porta direita / esquerda (menor)

* 694.723.7069

externo 150mm



aço 3,00mm

5MB-557

L1622, 1624, LS1634
tirante da fechadura da porta direita / esquerda (maior)

* 694.723.7469

interno 64mm



aço 3,00mm

5MB-558

OF 1417, 1721, OH 1421, 1621
mola do retorno do pedal da embreagem

* 382.993.7010 ** 5079

interno 120mm



aço 5,00mm

5MB-559

O371, O400
mola do pedal da embreagem

* 664.993.3110 ** 5080

interno 100mm



aço 3,00mm

5MB-561

O371, O400
mola do pedal de freio

* 301.993.0310 ** 5081

Ø 220mm



aço 3,00mm

5MB-562

L, LS1838, L, LK, LS2638
dif - HL7/025 - HL7/026
trava do cubo traseiro

* 346.994.0439

interno 63mm



aço 2,00mm

5MB-565

OF1417, 1721, OH1421, 1621
mola do retorno do pedal de freio

* 673.993.0110 ** 5083

externo 47mm



aço 1,80mm

5MB-566

mola pressão do cabo do acelerador

* 600.721.519 ** 5084

externo 65mm



aço 1,80mm

5MB-589

O371
mola do radiador do óleo

* 314.993.0201

interno 155mm



aço 4,50mm

5MB-4000

ACCELO 815 1016 1316
mola do patim de freio

* MO 216

interno 240mm



aço 4,20mm

5MB-4001

ACTROS-ATEGO
LK e LN MK SK NG
mola do patim de freio

* 346.993.0810

interno 235mm



aço 4,00mm

5MB-4002

AXOR-ACTROS MP2-MP3
ATEGO 2 OH-OM
mola do patim de freio

* 945.993.0010

interno 104mm



aço 2,00mm

5MB-4003

MB O370 O400
mola alavanca acelerador parada do motor

* 319.993.0810

55mm



aço 7,00mm

5MB-4004

AMB 1215 - C 1999 - C 2000
mola pedal da embreagem

* a6739930601

AUTOPARTS
molas automotivas

MERCEDES-BENZ

acionadores de freio



7MB-535 D

Sprinter
1 roda - traseira direita
sistema Bendix 2254988



7MB-536 E

Sprinter
1 roda - traseira esquerda
sistema Bendix 2254988

AUTOPARTS
molas automotivas

MERCEDES-BENZ

diverso



9MB-486

OM447, OH1628L, 2635, 1941
kit trava plato embreagem

* 000.252.0646



9MB-519

Carreta e Truck
trava do rolete do patim
(chapa)

* 381.421.8890



9MB-520

712, 912, 1215
conjunto mola do trambulador
do câmbio

* 688.260.8339

AUTOPARTS
molas automotivas

SCANIA

mola

interno 110mm



aço 1,30mm

5MSC-601

111, 112, 142
mola do acelerador
macia

* 172.570 ** 5601

interno 95mm



aço 4,000mm

5MSC-602

mola do patim de freio
dianteiro / traseiro

* 120.824 ** 5602

interno 230mm



aço 5,50mm

5MSC-603

110, 111
mola do pedal da embreagem

* 150.460 ** 5603

interno 220mm



aço 5,50mm

5MSC-605

112, 142
mola do capô

* 283.297 ** 5605

externo 189mm



aço 3,00mm

5MSC-607

112H
mola do pistão de freio do
motor

* SZ.1226 ** 5607



aço 1,60mm

5MSC-608

trava do rolete do patim

* 211.300.126

interno 250mm



aço 4,00mm

5MSC-609 ESP

113, 143
mola do patim de freio móvel
roda disco

* 1.309.465 ** 5608

interno 270mm



aço 4,00mm

5MSC-609 LON

SCANIA SERIE 4/5 114/124
mola do patim de freio móvel
roda disco

* 1.305.055 ** 5608

interno 210mm



aço 4,00mm

5MSC-610 ESP

113, 143
mola do patim de freio móvel
dianteiro - roda raiaida

* 1.674.593 ** 5609

interno 126mm



aço 1,20mm

5MSC-611

K112, K113
mola do acelerador
curta macia

externo 22mm



aço 1,30mm

5MSC-613

TR 112, TR 142, 111, 112, 140
mola aresta reduzida do
câmbio

* 254.775 ** 5612

externo 17mm



aço 1,30mm

5MSC-615

111, 112, 140, TR142
mola aresta do câmbio

* 214.119 ** 5614



aço 5,50mm

5MSC-617

Facchini
mola da tampa da caçamba
direita / esquerda

interno 190mm



aço 3,00mm

5MSC-622

L75, L76
mola da embreagem

* 41.485 ** 5619

externo 65mm



aço 1,80mm

5MSC-623

TR 112, 113, 142, 143
mola tirante freio motor

* 157.401 ** 5620

interno 120mm



aço 1,30mm

5MSC-625

TR 112, 142, 113, 143
mola do acelerador

* 266.828 ** 5622

interno 40mm



aço 1,20mm

5MSC-626

111, 112
mola do pedal da embreagem

* 130.591 ** 5623

interno 180mm



aço 1,00mm

5MSC-628

K112, K113
mola do acelerador (longa)

* 415.478 ** 5625

interno 300mm

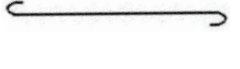

aço 6,00mm

5MSC-629

T112, 142
gancho da mola do capô

* 306.888 ** 5626



5MSC-630

Carreta
trava do rolete do patim
chapa

* 503365941

interno 88mm



aço 1,80mm

5MSC-636

113, 143
mola do pedal freio embreagem

* 1.319.522 ** 5629

externo 70mm

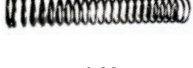

aço 1,00mm

5MSC-638

mola do garfo da embreagem

* 224.361 ** 5631

Ø 194mm

aço 2,00mm

5MSC-639

110, 111, 140, TR 112, TR 142
anel trava caixa disco câmbio

* 184.492 ** 5632

interno 140mm



aço 1,30mm

5MSC-640

94, 114, 124
mola do acelerador

* 329.647 ** 5633

Ø 100mm



aço 2,50mm

5MSC-641

111, 112, 113
anel trava do sincronizado seletora

* 194.118 ** 5634

Ø 66mm



aço 2,00mm

5MSC-642

111, 112, 113
anel trava câmbio entalhado

* 284.990 ** 5635

Ø 22mm

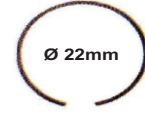

aço 2,00mm

5MSC-643

anel trava rolamento alavanca câmbio

aço 6,00mm



5MSC-645D

mola do gancho da caçamba direita

aço 6,00mm



5MSC-645E

mola do gancho da caçamba esquerda

externo 24,5mm



aço 4,00mm

5MSC-648

mola terminal de direção

* 159.984

interno 100mm



aço 1,80mm

5MSC-651

113
mola comando do acelerador

* 183.898

interno 345mm

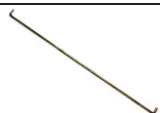

aço 4,00mm

5MSC-653

R112, 113, T112, 113
mola da fechadura maior

*

Ø 90 mm



aço 3,00mm

5MSC-654

Série 4
anel trava sincronizador do câmbio

* 130.0065

Ø 137mm



aço 4,00mm

5MSC-655

94, 14, 24, 64 - P, G, R, T
anel trava da calota dianteira

* 153.1529

aço 3,40mm

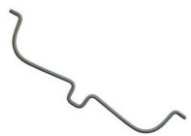

5MSC-656

Série 4
trava bomba óleo câmbio

* 130.7099

230mm



aço 4,00mm

5MSC-657

SCA 112, 142
haste da fechadura menor

* 296.117

intern 230mm



aço 1,60mm

5MSC-658

SCA SÉRIE 4
mola do acelerador

* 136.4184

Ø 120mm

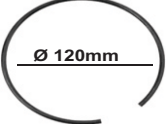

aço 4,20mm

5MSC-659

SCA SÉRIE 4
anel de retenção do câmbio
GRS0925/O925R/GR875R

* 1730173

Lançamento

externo 230mm



aço 1,50mm

5MSC-660

SCA SÉRIE 4
mola pressão radiador óleo motor

* 302473

Lançamento

externo 67,00mm



aço 1,90mm

5MSC-661

SCA SÉRIE 5
mola do filtro de óleo rotativo
11,3 x 7,5 x 1,9 x 6

* 1803270

Lançamento

interno 56,00mm



aço 2,50mm

5MSC-662

SCA 112
mola do pedal de freio

* 318601

Lançamento

AUTOPARTS
molas automotivas

VOLARE

reparo da sapata de freio



4VOL-2081

Furgovan 99/
1 roda - dianteira

* 6007005569008

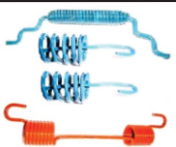

4VOL-8900C

V8
1 roda - dianteira

* 6007005569008



4VOL-8903

W8, W9
1 roda - dianteira

* 6007005514004

AUTOPARTS
molas automotivas

VOLARE

mola

interno 93mm



aço 1,20mm

5VOL-8940

A5, A6, A8, V8, W8 01/04
mola do acelerador

interno 120mm



aço 2,50mm

5VOL-8941

A5, A6, A8, V8, W8
mola do pedal da embreagem

* 8002.105.054.01.7

AUTOPARTS
molas automotivas

VOLKSWAGEN

reparo da sapata de freio



2MW-851

11.130, 13.130
2 rodas - dianteira

* T13.698.683A ** 6243



2MW-852

11.130, 13.130
2 rodas - traseira

* T13.698.683 ** 6244

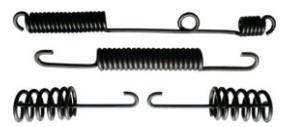

2MW-858

6.80, 6.90, 7.90
1 roda - traseira completo

* TO60931A, TO609309 ** 6245

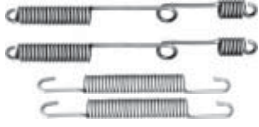

2MW-859

6.80, 6.90, 7.90, 7.110
2 rodas - traseira parcial

* 3VW45 * 1020 ** 6246



2MW-873

11.130, 13.130
1 roda - traseira

* T13.698.683 ** 6248

AUTOPARTS
molas automotivas

VOLKSWAGEN

reparo centralizador de freio

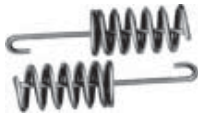

3MVW-860

6.80, 6.90, 7.90, 7.110
1 roda - traseira completo

* TO6609293 * 2VW32 * 1212** 6250



3MVW-8938

6.80, 6.90, 7.90, 7.110
1 roda - dianteiro pino 70mm

** 6255

AUTOPARTS
molas automotivas

VOLKSWAGEN

reparo da sapata de freio completo

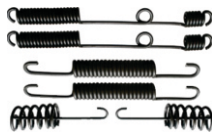

4MVW-875

6.80, 6.90, 7.90, 7.110
2 rodas - traseira completo

* 7VW82 ** 6247



4MVW-8900C

7.100, 7.110, 7.110S, 8.120, 8.140, 8.150
1 roda - diant. / tras. completo

* 2RG.607.041



4MVW-8901C

11.130, 14.130 94/
1 roda - dianteira / traseira completo



4MVW-8902

Master 325, 100, 120HD
1 roda - completo



4MVW-8903

8.120, 8.140, 8.150, 14.210
1 roda - dianteira / traseira

* TE3607039A



4MVW-8914

Tubeless 15 x 7Q plus 98/00
1 roda - completo



4MVW-8915

Tubeless 5 x 7Q plus
1 roda - completo

AUTOPARTS
molas automotivas

VOLKSWAGEN

mola

interno 100mm



aço 2,00mm

5MVW-853

11.130, 13.130
mola do retorno do pedal da embreagem

* 251.721.363 ** 6207

interno 140mm



aço 3,00mm

5MVW-854

14.210, 12.000, 14.000
mola do patim de freio traseiro

* TE3.607.041 ** 6208

externo 54mm



aço 1,80mm

5MVW-855

11.130, 13.130
trava R mancal do rolamento da embreagem

* T13.141.177 ** 6238



aço 1,60mm

5MVW-861

12.140, 35.300
trava do rolete do patim de freio

* TE3.607.033 ** 6237

externo 100mm



aço 3,30mm

5MVW-863

6.90, 7.90, 7.110
mola fixadora do patim do freio dianteiro / traseiro

* T06.609.283 ** 6203

interno 220mm



aço 4,50mm

5MVW-864

14.210
mola do patim dupla móvel dianteiro / traseiro

* TE3.607.039 ** 6204

interno 220mm



aço 4,50mm

5MVW-864EX

14.210
mola do patim dupla móvel dianteiro / traseiro

interno 216mm



aço 5,00mm

5MVW-865

23.220, 24.220, 26.220
mola do patim de freio dupla com rabicho

* 2RP.607.039A ** 6205

interno 180mm



aço 3,40mm

5MVW-866

7.100, 8.140
mola do patim de freio traseiro

* 2RD.607.039 ** 6206

externo 88mm



aço 3,40mm

5MVW-867

7.100, 8.140
mola fixadora do patim de freio dianteiro / traseiro

* 2RD.607.040 ** 6209

interno 160mm



aço 1,50mm

5MVW-868

14.200, 210, 220, 16.210, 220
mola do retorno do pedal do acelerador

* TAR.721.619 ** 6210

interno 205mm



aço 5,00mm

5MVW-869

16.180, 16.210
mola do patim de freio pino forjado

* 2RP.607.039 ** 6211

interno 170mm



aço 3,00mm

5MVW-870

7.100, 8.140
mola do patim traseiro

* 2RD.607.041 ** 6212

interno 255mm



aço 4,00mm

5MVW-871

12.140
mola de retorno do patim de freio inferior

* T12.607.039 ** 6213

interno 150mm



aço 1,00mm

5MVW-872

14.170, 16.220
mola de retorno do cabo do acelerador

* TAR.721.619A ** 6214

externo 210mm



aço 3,20mm

5MVW-8903

6.90, 7.90, 7.110
mola do patim de freio superior dianteiro / traseiro

* T06.609.301A ** 6201

interno 180mm



aço 4,000mm

5MVW-8904

6.90, 7.90, 7.110
mola do patim de freio inferior dianteiro / traseiro

* T06.609.309 ** 6202

interno 154mm



aço 4,00mm

5MVW-8905

12.140
mola do patim de freio

* T12.607.041

interno 208mm



aço 5,00mm

5MVW-8906

16.180CO, 16.210CO
mola do patim de freio

** 6211

externo 53mm



aço 1,60mm

5MVW-8907

12.140 a 35.300, 16.180CO
mola trava eixo do garfo do câmbio

* TE3.311.983

externo 70mm



aço 4,00mm

5MVW-8908

mola do pedal do freio

* 281.721.163 ** 6218

interno 110mm



aço 1,00mm

5MVW-8909

14.210, 16.210
mola do retorno do cabo do acelerador

* TE3.130.525 ** 6219

interno 75mm



aço 1,00mm

5MVW-8910

7.100S, 8.140
mola do retorno do cabo do acelerador

* 2RD.721.339 ** 6220

interno 170mm



aço 1,00mm

5MVW-8911

16.170, 24.220, 24.250
mola do retorno do pedal do acelerador

* T.JG.130.525B ** 6221

interno 115mm



aço 2,10mm

5MVW-8916

12.170, 13.190, 14.170, 15.190
mola tração cabo acelerador

* 2TD.721.339 ** 6222

interno 170mm



aço 1,00mm

5MVW-8918

16.300, 17.310, 18.310, 35.300
mola da alavanca do cabo do acelerador (Cummins série C)

* 2RK.130.525 ** 6223

interno 160mm



aço 1,50mm

5MVW-8919

13.180, 15.180, 17.210, 23.210
mola da alavanca do cabo do acelerador

* 2TJ.721.619A ** 6224

interno 160mm



aço 4,00mm

5MVW-8922

Micro 8.1200D
mola do patim de freio

* 2R0.609.465 ** 6225

externo 66mm



aço 7,00mm

5MVW-8923

6.90, 7.90, 11.130, 13.130
mola da tranca da cabine

* T.J3.899.533 ** 6226

interno 82mm

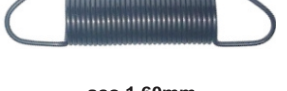

aço 1,60mm

5MVW-8924

16.210
mola do acelerador

* 2TJ.721.619 ** 6227

externo 98mm



aço 1,60mm

5MVW-8925

16.210
mola do acelerador

* 2TJ.721.619A ** 6228

externo 70mm



aço 4,00mm

5MVW-8926

mola de torção

* 2PO.721.163

interno 67mm



aço 1,00mm

5MVW-8927

7.90, 7.110S
mola do acelerador

* T12.721.339 ** 6229

externo 44mm



aço 1,60mm

5MVW-8928

24.250, 35.300
mola da tampa da caixa RT

** 6230

externo 118mm



aço 1,00mm

5MVW-8930

mola do acelerador

* 2RL.721.619 ** 6231

externo 52mm



aço 1,50mm

5MVW-8931

8.140, 16.180, 16.210
mola do retorno do cabo do acelerador

* TAR.721.519 ** 6232

externo 44mm



aço 1,60mm

5MVW-8932

7.90, 7.110S, 12.140, 14.170
mola pressão do cabo do acelerador

* 600.721.519 ** 6233

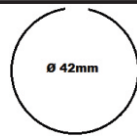

Ø 42mm

aço 2,00mm

5MVW-8933

7.90, 7.110S, 12.140, 14.170
anel de retenção do rolete

* TD.131.118.100 ** 6239

externo 130mm



aço 3,40mm

5MVW-8934

12.140, 14.150, 16.170, 35.300
mola retentora central da cuíca

* T.JG.607.959 ** 6234

externo 144mm



aço 4,00mm

5MVW-8935

11.130, 13.130
mola central da cuíca sistema Varga SPMO41577

* T13.07959 ** 6235

externo 52mm



aço 3,00mm

5MVW-8936

6.90, 7.90, 7.110S
trava da mola do retentor da sapata (sistema Varga)

* T06.609.279 ** 6240

interno 135mm



aço 3,00mm

5MVW-8937

14.210, 12.000, 14.000
mola de retenção da sapata de freio

* 2RG.607.041 ** 6236

interno 150mm



aço 3,00mm

5MVW-8939

mola do para-choque 3/4

interno 215mm



aço 5,00mm

5MVW-8940

Tubelless 5x7 Qplus
mola do patim de freio dupla móvel

externo 52mm



aço 6,00mm

5MVW-8942

14.216, 16.210
trava do patim

* TE3.607.543

interno 214mm



aço 4,50mm

5MVW-8944

Master
mola do patim de freio dupla móvel

interno 220mm



aço 5,00mm

5MVW-8946

17230 OD, 17260 OD
mola do patim de freio dianteiro e traseiro sist. 410mm

* 2W0609465

interno 155mm



aço 4,50mm

5MVW-8947

DELIVERY EXPRESS
mola fixação sapata de freio

* MO-216

externo 195,00mm



aço 4,00mm

5MVW-8948

CONSTELLATION
13180E à 31370E
haste do pino da porta

interno 122mm



aço 1,40mm

5MV-751

mola do acelerador

* 1.587.404 ** 5901

interno 210mm



aço 5,50mm

5MV-752

N-NL 10, 12, B58, 10M
mola do patim do freio dianteiro

* 346.499 ** 5902

interno 213mm



aço 5,50mm

5MV-753

N-NL 10, 12, B58, 10M
mola do patim do freio traseiro

* 1.586.683 ** 5903

AUTOPARTS
molass automotivas

VOLVO
mola

interno 205mm



aço 4,00mm

5MV-754

N-NL 10, 12
mola do esticador da correia

* 1.545.268 ** 5904

interno 178mm



aço 3,40mm

5MV-756

N10, 12
mola do pedal de embreagem

* 1.586.291 ** 5906

externo 183mm

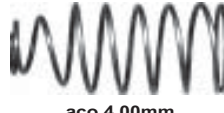

aço 4,00mm

5MV-758

mola servo da embreagem

* 8.157.770 ** 5907

interno 205mm



aço 5,00mm

5MV-759

mola do patim de freio

* 20506333

interno 135mm



aço 3,00mm

5MV-760

mola do patim gancho móvel

* 20506293

interno 145mm



aço 1,80mm

5MV-763

N10, 12
mola do acelerador

* 65.041 ** 5910

externo 140mm



aço 4,00mm

5MV-764

NL10
mola do esticador da correia intercooler

* 471.318 ** 5911

externo 165mm



aço 9,00mm

5MV-765

N10, N12
mola da suspensão da cabine

* 1.620.601 ** 5912

externo 206mm

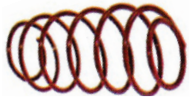

aço 5,00mm

5MV-766

N10, N12, NL10, NL12
mola da cuíca traseira
(pequena, emergência)

* 6.885.319 ** 5913

interno 184mm



aço 3,40mm

5MV-767

FH 12, NH 12
mola do pedal da embreagem

* 1.668.181

externo 220mm



aço 4,50mm

5MV-769

VM210, VM260
mola do retorno patim de freio

* 205066296



Ø 88mm

aço 3,20mm

5MV-770

VOLVO FH FM
trava bucha articulação da cabine

* 977173

interno 165mm



aço 1,80mm

5MV-771

FH FH12 FH16 Fh10 FM12
mola da alavanca do câmbio

* 1069899

eixo Ø22mm



aço 4,50mm

5MV-772

FH FM
mola pedal da embreagem

* 8189666

* Lançamento



5MV-773

VM
mola retorno alavanca marcha

* 20925787

* Lançamento

AUTOPARTS
molares automotivas

ONIBUS

mola



aço 4,00mm

5BC-001

MARCOPOLO NEO BUS
CAIO APACHE
kit par molas banco cadeirante
direito/esquerdo

* 08416

* Lançamento

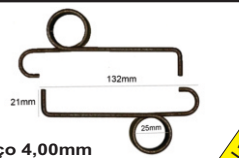

aço 4,00mm

5BC-002

MASCARELLO
kit par molas banco cadeirante
direito/esquerdo

* 08416

* Lançamento



82MM

5BC-003

COMIL SVELTO
mola assento banco carona

* 589468

* Lançamento



aço 4,00mm

5BC-004 D

CAIO
mola direita bco retrátil

* 0051.1048.001

* Lançamento



aço 4,00mm

5BC-005 E

CAIO
mola direita bco retrátil

* 0051.1048.001

* Lançamento

AUTOPARTS
molares automotivas

cuíca de freio

externo 150mm



aço 4,00mm

5MC-501

MERCEDES-BENZ
mola do corpo intermediario da
câmara spring brake

** 5340

externo 175mm



aço 4,00mm

5MC-502

MERCEDES-BENZ
mola da cuíca 7", 8", 9"
(234141 Bendix)

* 000.423.2192

externo 175mm



aço 4,50mm

5MC-503

MERCEDES-BENZ
mola da cuíca de 9"

externo 134mm



aço 3,40mm

5MB-548

CARRETA, TRUCK
mola da câmara do spring brake

externo 200mm



aço 5,00mm

5MV-766

N10, N12, NL10, NL12
mola cuíca traseira pequena
(emergência)

externo 254mm



aço 3,40mm

5MC-4600

mola do servo da embreagem
(cônica)

externo 160mm



aço 4,00mm

5MC-4601

mola da cuíca tri-top 24x16
(Knorr)

externo 170mm



aço 4,00mm

5MC-4602

mola da cuíca 7", 8", 9"
(ponta fina)

* 6107 Boechat

externo 170mm



aço 4,20mm

5MC-4604

mola da cuíca tri-stop 14x24
(Wabco)

externo 142mm



aço 3,80mm

5MC-4605

mola tri-stop cônica 12x16
(Wabco)

externo 152mm



aço 5,00mm

5MC-4607

CARRETA
mola da cuíca freio a ar 7", 8", 9"

* 234141 Bendix

externo 226mm



aço 5,00mm

5MC-4608

mola da cuíca 7", 8", 9"
5mm - bicônica - Bendix

* 000.423.2192

externo 136mm



aço 3,40mm

5MC-4609

mola da cuíca
3,6mm - Varga

externo 160mm



aço 4,00mm

5MC-4610

mola da cuíca 7", 8", 9"
ponta larga

externo 150mm



aço 4,00mm

5MC-4616

13.140, 14.140
mola inferior câmara freio
Varga

* T13.607.965

externo 154mm



aço 4,50mm

5MC-4618

mola cilindro membrana 16 e 20
(4B.51.433 - Knorr)

* 000.423.5393

externo 144mm



aço 4,00mm

5MC-4619

mola cilindro membrana 12
(4B.55.424 - Knorr)

* 000.423.4693

externo 225mm



aço 5,00mm

5MC-4620

1113, 2213
mola cuíca servo freio
(1.484.643.053)

* 001.431.6493

externo 200mm



aço 5,00mm

5MC-4621

mola cilindro tristop tipo 30SSB
(251326 - Bendix)

* 001.423.6592

externo 160mm



aço 4,00mm

5MC-4622

mola cilindro membrana
tristop 16/24 20/30 24/30

* 000.423.5293

externo 180mm



aço 4,20mm

5MC-4623

mola cilindro membrana 14
tristop 14/24 - Wabco

* 000.423.5193

externo 140mm



aço 4,00mm

5MC-4624

mola cilindro membrana 12
tristop 12/16 - Wabco

* 000.423.5093

externo 170mm



aço 4,50mm

5MC-4625

mola cilindro membrana
tristop 20/24 24/30 - Wabco

* 000.423.5493

externo 136mm



aço 4,50mm

5MC-4626

mola cilindro tristop 16/24, 20/24
(4B.57.677 - Knorr)

* 000.423.4893

interno 140mm



aço 4,50mm

5MC-4627

mola cilindro tristop 14/24
(4B.60.046 - Knorr)

* 000.429.4993

externo 150mm



aço 4,50mm

5MC-4628

mola cilindro membrana 14
(4B.57.369 - Knorr)

* 000.423.4793

externo 136mm



aço 4,00mm

5MC-4630

mola menor da câmara de
serviço 30x30

* T.JG.607.965

externo 140mm



aço 4,00mm

5MC-4631

mola da câmara de serviço
freio Master

* 2RD.607.965

externo 125mm



aço 4,00mm

5MC-4632

mola da câmara central e
serviço - freio Master

* 211.300.306

externo 130mm



aço 3,40mm

5MVW-8934

12.140, 14.150, 16.170, 35.300
mola retentora central da cuíca

* T.JG.607.959

externo 147mm



aço 4,00mm

5MVW-8935

11.130, 13.130
mola central da cuíca
(sistema Varga SPMO41577)

* T13.07959

AUTOPARTS
molas automotivas

**trava da
carroceria**



9TVC-001

pino trava com corrente
6x60mm

** 5331



9TVC-002

pino trava com corrente
7x70mm



9TVC-003

porca média - 5/8

** 5330



9TVC-004

porca pequena - 1/2



9TVC-005

porca grande - 3/4

** 5329

trava



4700

RUBERFIX
4x29x120



4701

CBT, MASSEY
4x27x93



4702

4x28x90



4703

4,8x29x93



4704

3x23x65



4705

Facchini
5,2x33x120



4706

Facchini
4,2x28x86



4707

2,5x18x41

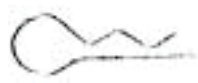

4708

VT JF 9020
4x27x85
zincada



4709

VT JE 9013
2,5x18x50
zincada



4711

ARC
5x38x106



4713

MARCHESAN
3x18x59



4714

BALDAN 7/32, NIMA 455
4,76x27x83



4715

BALDAN 7/32, NIMA 455
4,5x30x135
zincada



4716

TRUKAN
4,5x30x84
zincada



4717

TRUKAN
5,5x33x104
zincada



4718

5,5x46x142
zincada

externo 45mm



aço 2,50mm

4719

709, 912, 1218, 1418, 1620
trava cubo rolamento
embreagem

* 679.993.0025 ** 5098

externo 50mm



aço 2,00mm

4720

1214, 1418, 1618
trava cubo rolamento
embreagem - bicudo

* 381.254.0113 ** 5099

externo 57mm



aço 2,00mm

4721

1935, 36, 41, 45
trava cubo rolamento
embreagem

* 388.993.0025 ** 5100

externo 55mm



aço 3,00mm

4722

2214, 18, 1932, 33, O400
trava cubo rolamento
embreagem

* 317.993.0225

externo 28mm



aço 2,00mm

4723

1113 ao O362, 608, 708
trava cubo rolamento
embreagem

* 340.254.0013



4724

trava R parafuso roda
martelinho - 2,5x6x36



4725

trava R - 4x33x80



4726

trava R - 4x29x105



4727

trava R - 3x28x70

interno 195mm



aço 4,00mm

5MB-404/C

Carreta Randon (211.3010)
mola do patim fixa simples macia

* 000.993.0023 ** 5305

interno 205mm



aço 5,00mm

5MB-408R

Carreta
mola do patim dupla móvel sistema Bendix

* 000.993.1923 ** 5302

interno 190mm



aço 5,00mm

5MB-448R

Carreta
mola do patim dupla móvel sistema Bendix

* 000.993.2223 ** 5310

interno 220mm



aço 5,00mm

5MB-449R

Carreta (225.8196)
mola do patim dupla móvel freio Master - com rabicho

* 000.993.0010

interno 240mm



aço 4,20mm

5MB-4001

ACTROS-ATEGO LK e LN MK SK NG
mola do patim de freio

* 346.993.0810

interno 235mm



aço 4,00mm

5MB-4002

AXOR-ACTROS MP2-MP3 ATEGO 2 OH-OM
mola do patim de freio

* 945.993.0010

interno 104mm



aço 2,00mm

5MB-4003

MB O370 O400
mola alavanca acelerador parada do motor

* 319.993.0810

55mm



aço 7,00mm

5MB-4004

AMB 1215 - C 1999 - C 2000
mola pedal da embreagem

* a6739930601



5MB-4005

mola de torção JOST quinta roda 3 1/2 «

* AD01097JOO



4MB-4006

SPRINTER 311 313 415 515
2012 / 2015
reparo da sapata de freio

* 000.993.5307

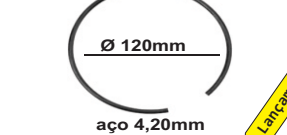

Ø 120mm

aço 4,20mm

5MSC-659

SCA SÉRIE 4
anel de retenção do câmbio GRSO925/O925R/GR875R

* 1730173

externo 230mm



aço 1,50mm

5MSC-660

SCA SÉRIE 4
mola pressão radiador óleo motor

* 302473

externo 67,00mm



aço 1,90mm

5MSC-661

SCASÉRIE 5
mola do filtro de óleo rotativo 11,3 x 7,5 x 1,9 x 6

* 1803270

interno 56,00mm



aço 2,50mm

5MSC-662

SCA 112
mola do pedal de freio

* 318601

eixo Ø22mm



aço 4,50mm

5MV-772

FH FM
mola pedal da embreagem

* 8189666

interno 155mm



aço 4,50mm

5MVW-8947

DELIVERY EXPRESS
mola fixação sapata de freio

* MO-216

externo 195,00mm



aço 4,00mm

5MVW-8948

CONSTELLATION 13180E à 31370E
haste do pino da porta

* 93161976C

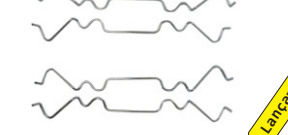

1IVC-2089

Nova Daily 3.0 16V, 70C16 08/
2 rodas - dianteira

* 58002233204



aço 13,00mm

5IVC-5013

TECTOR / CURSOR
mola fixação suspensão cabine

* 50006868

interno 120mm



aço 3,00mm

5IVC-5021

NOVA DAILY 3.0 16V 70C16/70C17 .../19 - 70-170
mola patim de freio

* 50006868

interno 227mm



aço 5,50mm

5IVC-5022

IVECO BUS 170s28
mola do retorno patim preta

* 500057411 * MO 223

35,0mm



aço 1,40mm

5MFOR-1895

CARGO 712 A 1415
mola torção / haste liberação da cabine

* 81DB-5B122-BB

aço 4,00mm

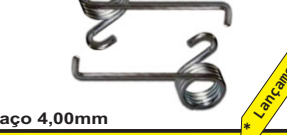

5BC-001

MARGOPOLO NEO BUS CAIO APACHE
kit par molas banco cadeirante direito/esquerdo * H33BN75L

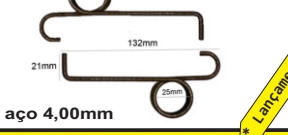

21mm 132mm 25mm

aço 4,00mm

5BC-002

MASCARELLLO
kit par molas banco cadeirante direito/esquerdo

* 08416



82MM

5BC-002

COMIL SVELTO
mola assento banco carona

* 589.4684



aço 4,00mm

5BC-004 D

CAIO
mola direita bco retrátil

* 0051.1048.001



aço 4,00mm

5BC-005 E

CAIO
mola direita bco retrátil

* 0051.1048.001

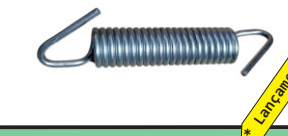

5MV-773

VM
mola retorno alavanca marcha

* 20925787

A CRISE, SEGUNDO EINSTEIN

Não pretendemos que as coisas mudem, se sempre fazemos o mesmo.

A crise é a melhor bênção que pode ocorrer com as pessoas e países, porque a crise traz progressos.

A criatividade nasce da angústia, como o dia nasce da noite escura.

É na crise que nascem as invenções, os descobrimentos e as grandes estratégias.

Quem supera a crise, supera a si mesmo sem ficar superado.

Quem atribui à crise seus fracassos e penúrias, violenta seu próprio talento e respeita mais os problemas do que as soluções.

A verdadeira crise, é a crise da incompetência.

O inconveniente das pessoas e dos países é a esperança de encontrar as saídas e soluções fáceis.

Sem crise não há desafios, sem desafios a vida é uma rotina, uma lenta agonia.

Sem crise não há mérito.

É na crise que se aflora o melhor de cada um.

Falar de crise é promovê-la e calar-se sobre ela é exaltar o conformismo.

Em vez disso, trabalhemos duro.

Acabemos de uma vez com a única crise ameaçadora, que é a tragédia de não querer lutar para superá-la.

Albert Einstein



AUTOPARTSMOLAS.COM.BR

Nilton Melo
(11) 97625-9069
email : nilton@bnrep.com.br